

Essentra Components does not warrant that the files will be error free and may create new versions ("Upgrades") at any time, which may correct such errors. Essentra Components has no obligation to notify you of such upgrades. Any upgraded file will be published to the website, when it becomes available.

You are not permitted to load any of the files on to a network server for the purposes of distribution to one or more other computer(s) on that network or to effect such distribution. Essentra Components shall not be liable for any loss or damage whatsoever or however caused, arising directly or indirectly from the use of the files.

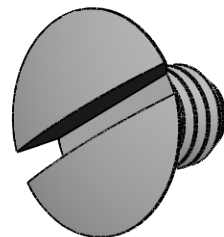
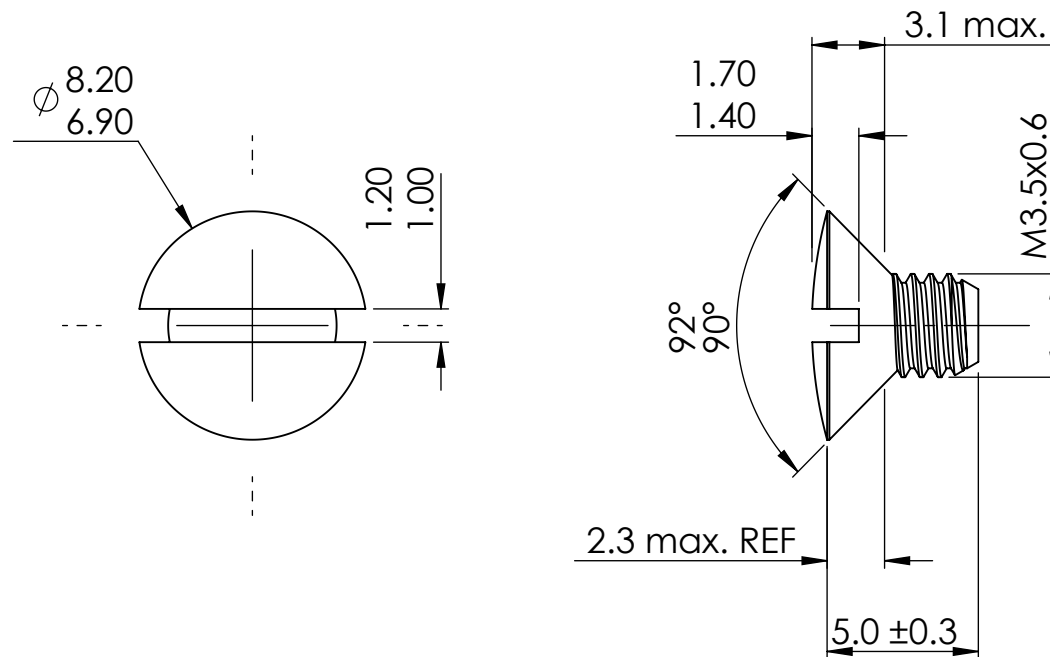

STATUS

AWAITING APPROVAL

UNLESS OTHERWISE STATED

ALL DIMENSIONS IN mm

DO NOT SCALE

LINEAR TOLERANCE

THIRD ANGLE PROJECTION

SIZE	(0)	(0.0)	(0.00)
0-10mm	±0.5	±0.15	±0.10
>10-30	±0.5	±0.20	±0.15
>30-50	±0.5	±0.30	±0.20
>50-100	±0.8	±0.50	±0.25
>100-200	±1.5	±0.80	±0.40
>200-300	±2.0	±1.20	±0.80
>300-500	±3.0	±2.00	±1.00
>500	±5.0	±3.00	±1.50

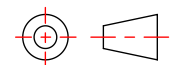

ANGULAR TOLERANCE ±0.5 DEGREES
 UNSPECIFIED RADII 0.25mm
 DRAFT ANGLE 0.5 DEGREES
 DIMENSIONS IN BRACKETS [] ARE
 IN INCHES FOR REFERENCE ONLY

CREATE DATE 02.03.2021

4:1 ORG. SCALE

ITEM CODE 10397725

NYLON 6/6 MATERIAL

LEGACY NUMBER 50M035060L005

NATURAL COLOUR / FINISH

TITLE:
OVAL SLOTTED MACHINE SCREW

DWG. No. 10397725

SHEET	ISSUE
1 of 1	1